



THOMAS

USE AND MAINTENANCE MANUAL

SAR 440 SA GDS



01/2006



Contents

Contents	"	2	7.1 - Blade tension assembly	"	10
Ordering spare parts	"	2	7.2 - Blade guide blocks	"	10
Guarantee	"	2	7.3 - Vice	"	11
Machine certification and identification marking	"	3	7.4 - Regulating the cutting angle	"	11
CHAPTER 1			7.5 - Blade-cleaning brush	"	11
Reference to accident-prevention regulations	"	4	7.6 - Regulating the height of the cut	"	11
1.1 - Advice for the operator	"	4	7.7 - Regulating the cutting speed	"	11
1.2 - Location of shields against accidental contact with the tool	"	4	7.8 - Changing the blade	"	12
1.3 - Electrical equipment according to European Standard "CENELEC EN 60 204-1"	"	4	CHAPTER 8		
1.4 - Emergencies according to European Standard "CENELEC EN 60 204-1"	"	4	Routine and special maintenance	"	12
CHAPTER 2			8.1 - Daily maintenance	"	12
Recommendations and advice for use	"	4	8.2 - Weekly maintenance	"	12
2.1 - Recommendations and advice for using the machine	"	4	8.3 - Monthly maintenance	"	12
CHAPTER 3			8.4 - Six-monthly maintenance	"	12
Technical characteristics	"	5	8.5 - Oils for lubricating coolant	"	12
3.1 - Table of cutting capacity and technical details	"	5	8.6 - Oil disposal	"	12
CHAPTER 4			8.7 - Special maintenance	"	12
Machine dimensions - Transport - Installation			CHAPTER 9		
Dismantling	"	5	Material classification and choice of tool	"	13
4.1 - Machine dimensions	"	5	9.1 - Definition of materials	"	13
4.2 - Transport and handling of the machine	"	6	9.2 - Selecting blade	"	13
4.3 - Minimum requirements for the premises housing the machine	"	6	9.3 - Teeth pitch	"	13
4.4 - Anchorage of standard machine	"	6	9.4 - Cutting and advance speed	"	14
4.5 - Instructions for electrical connection	"	6	9.5 - Blade running-in	"	14
4.6 - Instructions for assembly of the loose parts and accessories	"	6	9.6 - Blade structure	"	14
4.7 - Disactivating the machine	"	6	9.7 - Blade type	"	14
4.8 - Dismantling	"	6	Teeth shape and angle	"	14
CHAPTER 5			Set	"	15
Machine functional parts	"	7	9.7.1 - Table of recommended cutting parameters	"	15
5.1 - Operating head or saw frame	"	7	CHAPTER 10		
5.2 - Vice	"	7	Machine components	"	16
5.3 - Bed	"	7	10.1 - List of spare parts	"	16
CHAPTER 6			CHAPTER 11		
Description of the operating cycle	"	8	Wiring diagrams	"	21
6.1 - Starting up and cutting cycle	"	8	Schema elettrico idraulico	"	23
CHAPTER 7			CHAPTER 12		
Regulating the machine	"	9	Troubleshooting	"	24
			12.1 - Blade and cutting diagnosis	"	24
			12.2 - Electrical components diagnosis	"	28
			CHAPTER 13		
			Noise tests	"	28
			Plates and labels	"	29

Ordering spare parts

- When ordering spare parts you must state:
MACHINE MODEL
SERIAL NUMBER
PART REFERENCE NUMBER

Without these references WE WILL NOT SUPPLY the spares. See point 10.1 - list of spare parts -

Guarantee

- The Company guarantees that the machine to which this manual refers has been designed and built to comply with safety regulations and that it has been tested for functionality in the factory.
- The machine is guaranteed for 12 months: the guarantee does not cover the electric motors, electric components, pneumatic components or any damage due to dropping or to bad machine management, the failure to observe maintenance standards or bad handling by the operator.
- The buyer has only the right to replacement of the faulty parts, while transport and packing costs are at his expense.
- The serial number on the machine is a primary reference for the guarantee, for after-sales assistance and for identifying the machine for any necessity.



Machine certification and identification marking

MACHINE LABEL

THOMAS S.p.A.		CE
via Pasubio, 32 36033 ISOLA VIC. - ITALIA		
MODEL	SAR	
TYP	440 SA GDS	
SERIAL NUMBER		
YEAR OF MANUFACTURE		

(Space reserved for the NAME and STAMP of the DEALER and/or IMPORTER)

1 REFERENCE TO ACCIDENT - PREVENTION REGULATIONS

This machine has been built to comply with the national and community accident-prevention regulations in force. Improper use and/or tampering with the safety devices will relieve the manufacturer of all responsibility.



1.1 - Advice for the operator

- Check that the voltage indicated on the plate, normally fixed to the machine motor, is the same as the line voltage.
- Check the efficiency of your electric supply and earthing system; connect the power cable of the machine to the socket and the earth lead (yellow-green in colour) to the earthing system.
- When the saw frame is in suspend mode (up) the toothed blade must not move.
- Only the blade section used for cutting must be kept unprotected. Remove guarding by operating on the adjustable head.
- It is forbidden to work on the machine without its shields (these are all blue or grey in colour).
- Always disconnect the machine from the power socket before blade change or carrying out any maintenance job, even in the case of abnormal machine operation.
- Always wear suitable eye protection.
- Never put your hands or arms into the cutting area while the machine is operating.
- Do not wear loose clothing with sleeves that are too long, gloves that are too big, bracelets, chains or any other object that could get caught in the machine during operation; tie back long hair.
- Keep the area free of equipment, tools or any other object.
- Perform only one operation at a time and never have several objects in your hands at the same time. Keep your hands as clean as possible.
- All internal and/or internal operations, maintenance or repairs, must be performed in a well-lit area or where there is sufficient light from extra sources so as to avoid the risk of even slight accidents.

1.2 - Location of shields against accidental contact with the tool

- Blue or grey metal shield fixed frontally with screws to the fixed blade-guiding block (Ref. A).
- Blue or grey metal shield fastened on the front with screws onto the blade guide adjustable head to ensure maximum covering of blade and piece to be cut (Ref. B).
- Grey metal guards fastened to the saw frame with knobs, protecting the blade driving flywheels (Ref. C).

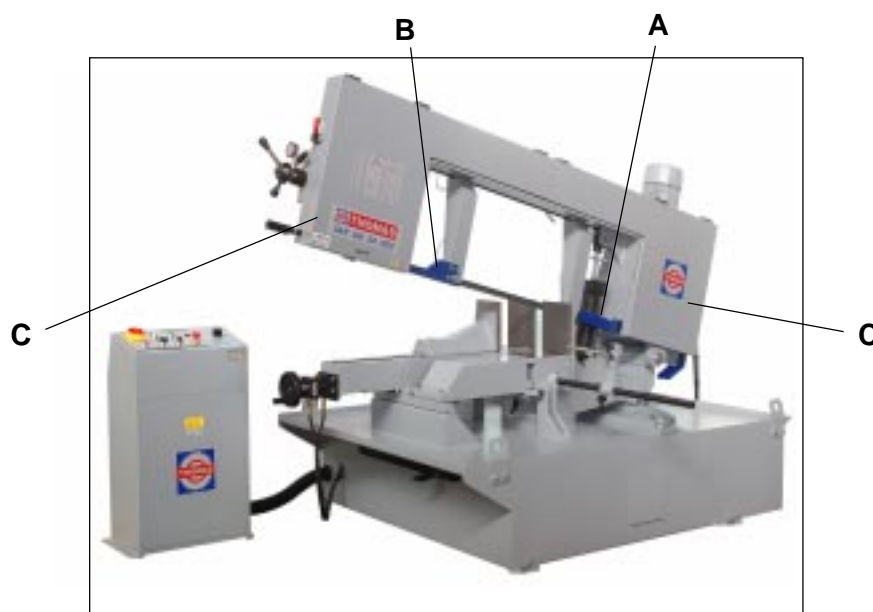

1.3 - Electrical equipment according to European Standard "CENELEC EN 60 204-1" which assimilates, with some integrating modifications, the publication "IEC 204-1"

- The electrical equipment ensures protection against electric shock as a result of direct or indirect contact. The active parts of this equipment are housed in a box to which access is limited by screws that can only be removed with a special tool; the parts are fed with alternating current at low voltage (24 V). The equipment is protected against splashes of water and dust.
- Protection of the system against short circuits is ensured by means of rapid fuses and earthing; in the event of motor overload, protection is provided by a thermal relay.
- In the event of a power cut, the specific start-up button must be reset.
- The machine has been tested in conformity with point 20 of EN 60204.

1.4 - Emergencies according to European Standard "CENELEC EN 60 204-1"

- In the event of incorrect operation or of danger conditions, the machine may be stopped immediately by pressing the red mushroom button.
- The casual or voluntary removal of the protection shield of the flywheels causes the stepping-in of a microswitch that automatically stops all machine functions.
- In case blade breaks, the band tightening microswitch/pressure switch disconnects all machine.

NOTE: Resetting of machine operation after each emergency stop is achieved by reactivating the specific restart button.

2 RECOMMENDATIONS AND ADVICE FOR USE

2.1 - Recommendations and advice for using the machine

- The machine has been designed to cut metal building materials, with different shapes and profiles, used in workshops, turner's shops and general mechanical structural work.
- Only one operator is needed to use the machine, that must stand as shown in the picture.

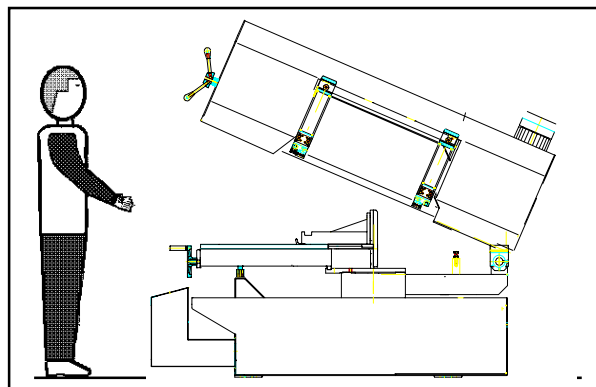

- Before starting each cutting operation, ensure that the part is firmly gripped in the vice and that the end is suitably supported.

These figures show examples of suitable clamping of different section bars, bearing in mind the cutting capacities of the machine in order to achieve a good efficiency and blade durability.

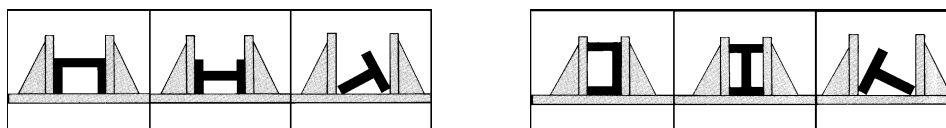

- Do not use blades of a different size from those stated in the machine specifications.
- If the blade gets stuck in the cut, release the running button immediately, switch off the machine, open the vice slowly, remove the part and check that the blade or its teeth are not broken. If they are broken, change the tool.
- Check saw frame return spring to ensure proper balancing.
- Before carrying out any repairs on the machine, consult the dealer or apply to THOMAS.

3 TECHNICAL CHARACTERISTICS

3.1 - Table of cutting capacity and technical details

0°	440	440	610 x 440
45° DX	440	440	500 x 230
45° SX	440	440	500 x 230
60° DX	320	300	320 x 245
60° SX	340	320	340 x 250

TECHNICAL DATA		
ELECTRIC MOTOR - 3-PHASE	kW	2,2
HYDRAULIC PUMP MOTOR	kW	1,1
COOLANT PUMP MOTOR	kW	0,18
FLYWHEEL Ø	mm	455
BLADE DIMENSIONS	mm	5200 x 34 x 1,1
VARIABLE BLADE SPEED	m/min	28 ÷ 140
VICE OPENING	mm	615
SAWFRAME INCLINATION	°	0
WORKING TABLE HEIGHT	mm	750
MACHINE DIMENSIONS	mm	2500x3000x2500
MACHINE WEIGHT	Kg	1570

4 MACHINE DIMENSIONS TRANSPORT INSTALLATION DISMANTLING

4.1 - Machine dimensions

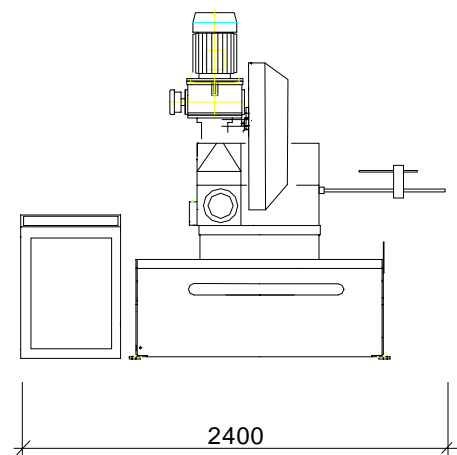
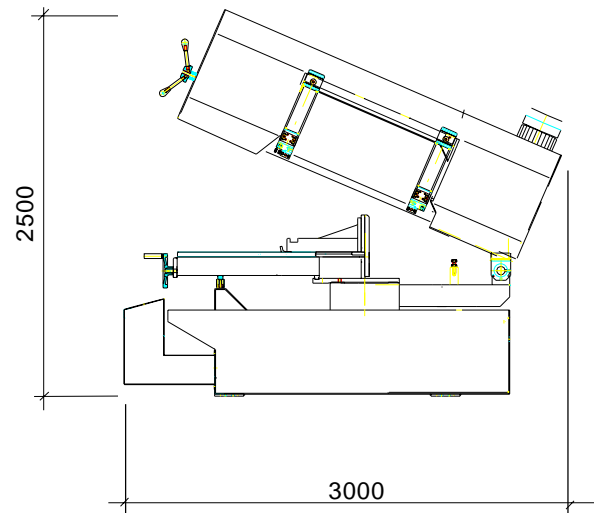

4.2 - Transport and handling of the machine

In case of transportation in its own packing, use a fork-lift truck. Sling the machine with special straps as illustrated making sure that the control panel has been securely placed on the machine base

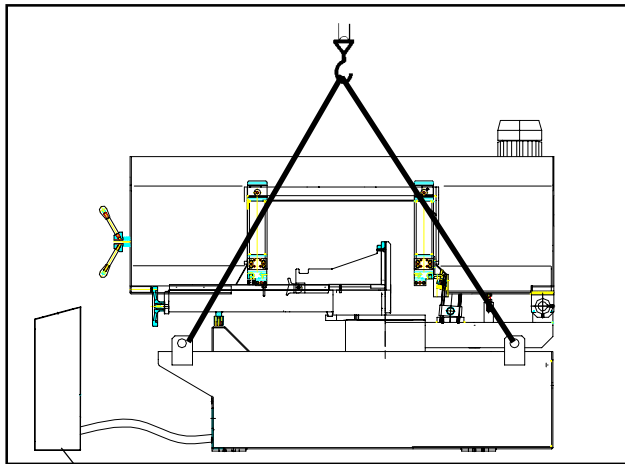

QUADRO ELETTRICO

4.3 - Minimum requirements for the premises housing the machine

- Mains voltage and frequency complying with the machine motor characteristics.
- Environment temperature from -10 °C to +50 °C.
- Relative humidity not over 90%.

4.4 - Anchorage of standard machine

INGOMBRO OPERATIVO = mm 2400

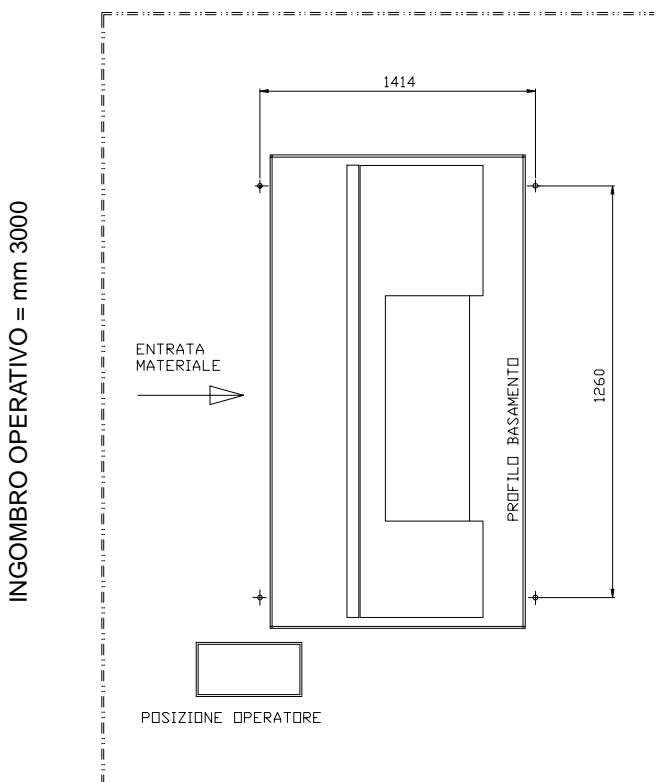

- Position the machine on a firm cement floor, maintaining, at the rear, a minimum distance of 1000 mm from the wall; anchor it to the ground as shown in the diagram, using screws and expansion plugs or tie rods sunk in cement, ensuring that it is sitting level.

4.5 - Instructions for electrical connection

- The machine is not provided with an electric plug, so the customer must fit a suitable one for his own working conditions:

1 - WIRING DIAGRAM FOR 4-WIRE SYSTEM FOR THREE-PHASE MACHINE - SOCKET FOR A 16A PLUG

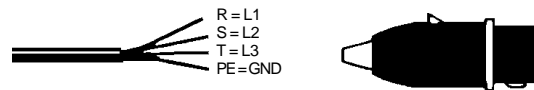

4.6 - Instructions for assembly of the loose parts and accessories

- Fit the components supplied as indicated in the photo:
- Mount the stock stop.
 - Mount the coolant liquid holder.

4.7 - Disactivating the machine

- If the sawing machine is to be out of use for a long period, it is advisable to proceed as follows:
 - 1) detach the plug from the electric supply panel
 - 2) loosen blade
 - 3) empty the coolant tank
 - 4) carefully clean and grease the machine
 - 5) if necessary, cover the machine.

4.8 - Dismantling

(because of deterioration and/or obsolescence)

General rules

If the machine is to be permanently demolished and/or scrapped, divide the material to be disposed of according to type and composition, as follows:

- 1) Cast iron or ferrous materials, composed of metal alone, are **secondary raw materials**, so they may be taken to an iron foundry for re-smelting after having removed the contents (classified in point 3);
- 2) electrical components, including the cable and electronic material (magnetic cards, etc.), fall within the category of material classified as being **assimilable to urban waste** according to the laws of the European community, so they may be set aside for collection by the public waste disposal service;
- 3) old mineral and synthetic and/or mixed oils, emulsified oils and greases are **special refuse**, so they must be collected, transported and subsequently disposed of by the old oil disposal service.

NOTE: since standards and legislation concerning refuse in gen-

eral is in a state of continuous evolution and therefore subject to changes and variations, the user must keep informed of the regulations in force at the time of disposing of the machine tool, as these may differ from those described above, which are to be considered as a general guide line.

5.3 - Bed

- Structure supporting the HEAD OR SAW FRAME, the VICE, the SWIVEL DEVICE with relative locking system, the ELECTRICALS, the BAR STOP and housing the coolant TANK for cut and pump.

5 MACHINE FUNCTIONAL PARTS

5.1 - Operating head or saw frame

- Machine part consisting of the members that transfer the motion (gearmotor, flywheels), the tightening/guiding (blade guide arms, blade tightening slide) and the tool lowering control.



5.2 - Vice

- Hydraulic locking system for cutting material. This device allows for the quick shifting of the vice and the possibility to cut inclinations to the left and right.



6 DESCRIPTION OF THE OPERATING CYCLE

Before operating, all the main organs of the machine must be set in optimum conditions (see the chapter on "Regulating the machine").

6.1 - Getting started

DESCRIPTION OF THE CUTTING PROCESS:

- Start the cutting cycle
- Automatic closure of the vice;
- Lowering of the sawframe (blade);
- Lifting of the sawframe (using selector);
- Opening of the vice.

PRELIMINARY OPERATIONS:

- Ensure that the machine is not on emergency stop; in which case free the red, mushroom shaped, button (1) on the panel of commands.
- Rotate the blade tension handwheel (8) until the blade tension pressure reaches **160 Bars**.
- Rotate the main switch (2) in position 1.
- Press the illuminated button (3) and ensure that the relative light is lit.
- Rotate the selector (5) to activate the lifting of the sawframe.

N.B.: if the lifting process does not occur, invert the electric alimentation phase (this operation is only to be done during installation).

Service pressure of the hydraulic unit should be approx. 50 BAR.

WARNING: always ensure that the vice is positioned to the extreme left or right of the counter vice to avoid accidental contact with the structure of the sawframe.

- Turn selector (9) to open the vice.
- Position the vice according to the dimension of the material to cut.
- Put the material to be cut in the vice, and approach the vice jaw up to **3 - 4 mm** with the handwheel.
- Ensuring that the latch is in place on the rack.
- Load the material to cut at the required cutting length and turn the selector (9) to lock the material in the vice.
- Bring the mobile blade guiding arm as close as possible to the object to be cut.
- Ensure that the cutting index correspond with the inclination desired and that the device is blocked.
- Before starting the cutting process, it is advisable to advance the blade to more or less 10 mm from the object to be cut, pressing, if necessary, selector (5).
- Press regulator (6) to the ideal cutting speed to suit the characteristics of the material. It is recommend that one always start off slowly, increasing the speed if necessary.
- Press button (4) to initiate the cutting cycle: control that the blade turns in the correct direction and that the cooling liquid flows sufficiently.

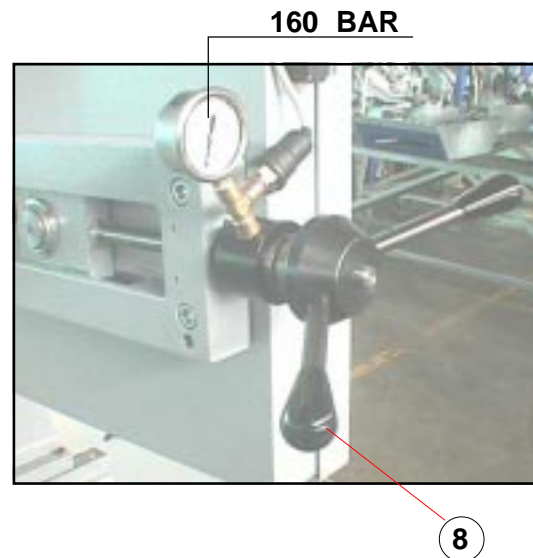

- Activate the hand wheel of the gear and set the speed control to suit the characteristics of the material to be cut. (do not regulate when the motor is off).
To regulate the desired speed refer to the plaque .
- In case of a wrong manoeuvre or to stop the cutting cycle, press the STOP button (10).
- At the end of the cutting cycle, the sawframe will stop in the inferior position. Rotate the selector (5) to activate the lifting of the sawframe.
- Turn selector (9) to open the vice.

ATTENTION:

- The cutting cycle can be executed even if the selector (9) has been switched for the open vice.
In fact, as you press START (3) the vice will close automatically. To open the vice again you will have to turn the selector (9) first to close the vice and then to open the vice.
- Once the cut has been executed the hydraulic pump will keep running for 20 seconds.

ATTENTION: Soon after the automatic shut off of the hydraulic pump, press the button (4) to open the vice automatically if the selector (9) was switched to vice open during the cutting phase.

Note: It is recommend not to use the saw to its maximum capacity for the first 50 working hours.



It is absolutely forbidden to approach the hands to the cutting area.

Note: for a proper lubrication and cooling during the cut, we recommend to use a mixture of 9 parts of water and one of oil.

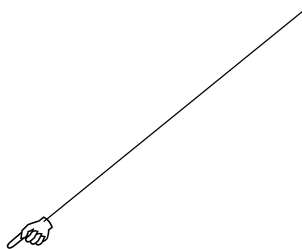
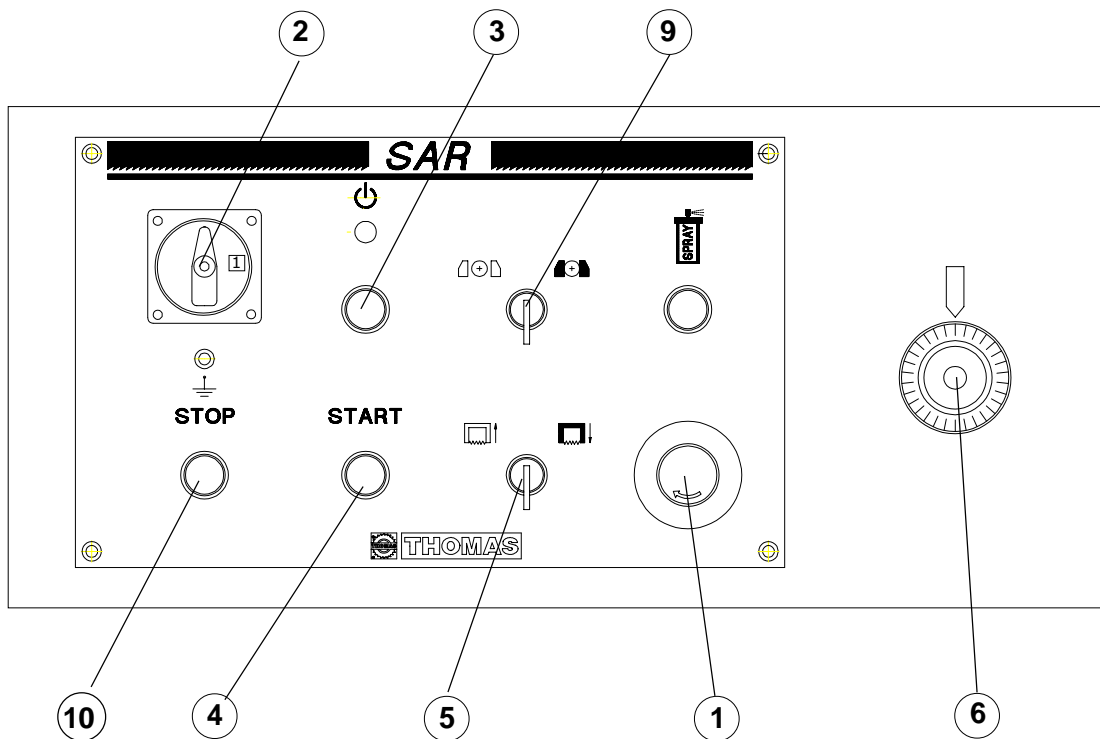

VOLANTINO VARIATORE VARIATOR - HAND WHEEL	8	9	10	11	12	13	14	15	16	17	18	19	20	21	22	23	24	25	26	27	28
POS. N°																					
VELOCITA' DI TAGLIO CUTTING SPEED	27.5	32	36.5	41.5	46	51	56	61	66.5	72	77.5	83	89	95	101	107	113	120	127	133	140
m/min																					

- the CUTTING SPEED and the TYPE of BLADE - combined with a suitable lowering of saw frame - are of decisive importance for cutting quality and for machine performance (for further details on this topic, see below in the chapter on “Material classification and blade selection”).
- **When starting to cut with a new blade, in order to safeguard its life and efficiency, the first two or three cuts must be made while exerting a slight pressure on the part, so that the time taken to cut is about double the normal time** (see below in the chapter on “Material classification and blade selection” in the section on *Blade running-in*).
- Press the red emergency button (1) when there are conditions of danger or malfunctions in general, so as to stop machine operation immediately.

7.2 - Blade-guide head

Blade guiding is obtained by means of plates which are regulated during the testing phase according to blade thickness.

CUTTING DIRECTION

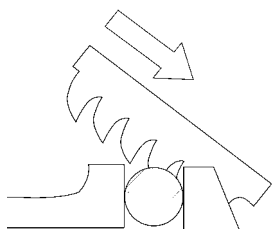

7 REGULATING THE MACHINE

7.1 - Blade tension assembly

The ideal blade tension is obtained by rotating the hand wheel belt tensioner until the blade tension pressure reaches **160 Bars** otherwise the saw will not operate.

N.B.: when the saw is not in use it is recommend to loosen the blade tension.

It is always recommend to use the blade sizes suggested in this manual.

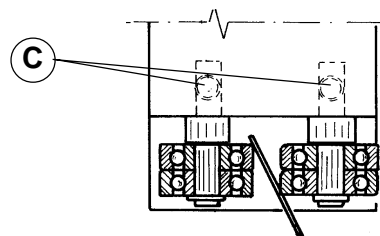
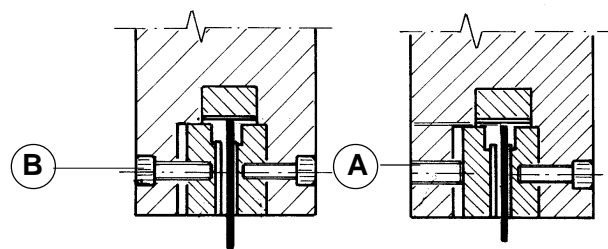
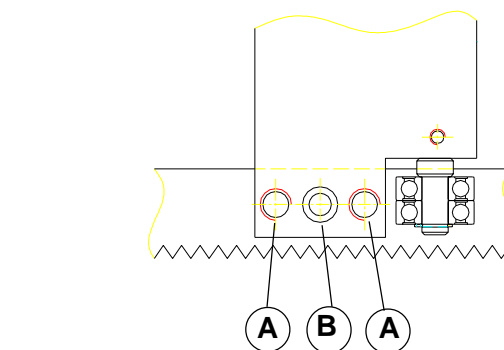

When replacing a blade, ensure that the belts are 1,1 mm thick as the guiding blade pads have been adjusted to this size. If using different size toothed belts, it will be necessary to proceed with a new registration as follows:

- Loosen the screws (B) and loosen dowels (A) widening the passage between the plates.
- Loosen the dowels (C) and rotate the pins to widen the passage between the bearings.
- Mount the new blade and rotate the hand wheel belt tensioner until the relative dip-switch is activated.
- Tighten the dowels (A) and then loosen them to allow a play of 0,04 mm to ensure the smooth running of the blade and fasten the screws (B).
- Rotate the pins until the bearings rest on the blade and block the screws (C).
- Ensure that between the blade and the superior bearings there are 0,2 - 0,3 mm of play; if necessary, loosen the screws (D) that block the heads and execute the necessary registration.

7.3 - Vice

- The rapid advancement of the vice to the object to be cut is obtained by manually moving the vice and lifting the latch (F). Before blocking the object to be cut with the hand wheel check that the latch is gripped to the rack.
- The vice unit can be positioned to the left or right of the blade. Ensure that this positioning has been executed correctly in order to avoid irreparable damage to the saw.
- It is recommended to keep the vice guide and ribbon clean and oiled at all times.

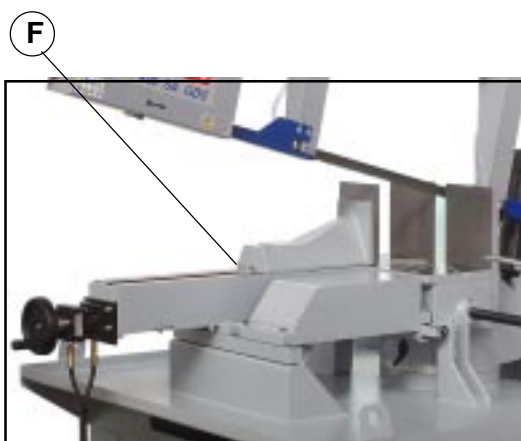

7.4 - Regulating the cutting angle

- Lift the sawframe.
- Operate the Lever (G) to release the rotation of the device.
- Rotate the sawframe to the desired angle referring to the graduated sector.
- Tighten the lever (G) to block the device from rotating.



G

INDICE

7.5 - Blade-cleaning brush

Ideal for the cleaning of the blade during its cutting cycle. Periodically check the integrity of the brush and if necessary proceed to an ulterior regulation to guarantee cleansing of the blade.

7.6 - Regulating the height of the cut

It is an accessory that permits the execution of lifting and/or nearing of the arch.

- Operate the selector button (H) to move the arch up and down to the desired position.

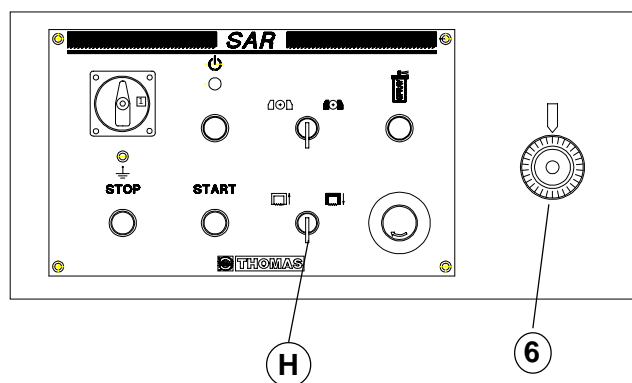

7.7 - Regulating the cutting speed

Regulation of the cutting speed can only be done with the motor-belt in motion.

To change the running speed, adjust with hand wheel and refer to the plaque.

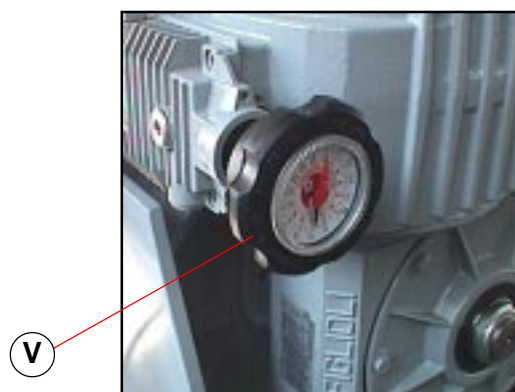

V

TABELLA LUBRIFICANTI

COMPONENTE PART.	LUBRIFICANTE OIL TYPE	QUANTITA' KG
RIDUTTORE REDUCTOR	SHELL TIVELA S320	1,6
VARIATORE VARIATOR	SHELL DO NAX TA	1,2

BEFORE PERFORMING THE FOLLOWING OPERATIONS, THE ELECTRIC POWER SUPPLY AND THE POWER CABLE MUST BE COMPLETELY DISCONNECTED.

7.8 – Replacing the blade

- Lift the sawframe in upright position.
- Loosen the blade with the hand wheel, remove the shield of the mobile blade guide and the shield of the belt cleaning brush.
- Open the posterior and anterior carter flywheels and extract the old blade from the flywheels and from the blade guide blocks.
- Insert the new blade inserting it between the plaques and then on the flywheel holder, taking note of the direction of the teeth in respect to the direction of the cut (refer to diagram below).
- Replace the tension of the blade checking that it is housed perfectly within the flywheels.
- Re-assemble the shields of the mobile guide blade and of the belt cleaning brush and close the carter flywheels cover, checking that the safety dip-switch is activated otherwise the machine will not operate when it is switched on.

WARNING: always use blades having dimensions specified in this manual and for which the blade guide heads have been set: otherwise, see chapter on "**Description of the operating cycle**" in the section Starting-up..

CUTTING DIRECTION

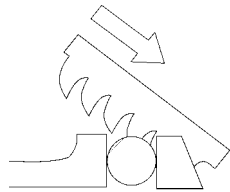

PROBABLE REPLACEMENT OF OTHER PARTS – REDUCTION GEAR OR SPEED CONTROL, MOTOR PUMP AND ELECTRICAL COMPONENTS – TO BE EXECUTED BY SPECIALISED AND COMPETENT PERSONNEL.

8 ROUTINE AND SPECIAL MAINTENANCE

THE MAINTENANCE JOBS ARE LISTED BELOW, DIVIDED INTO DAILY, WEEKLY, MONTHLY AND SIX-MONTHLY INTERVALS. IF THE FOLLOWING OPERATIONS ARE NEGLECTED, THE RESULT WILL BE PREMATURE WEAR OF THE MACHINE AND POOR PERFORMANCE.

8.1 - Daily maintenance

- General cleaning of the machine to remove accumulated shavings.
- Clean the lubricating coolant drain hole to avoid excess fluid.
- Top up the level of lubricating coolant.
- Check blade for wear.
- Rise of saw frame to top position and partial slackening of the blade to avoid useless yield stress.
- Check functionality of the shields and emergency stops.

8.2 - Weekly maintenance

- More accurate general cleaning of the machine to remove shavings, especially from the lubricant fluid tank.
- Removal of pump from its housing, cleaning of the suction filter and suction zone.
- Clean the filter of the pump suction head and the suction area.
- Cleaning with compressed air of blade guide arms (guide bearings, pads and drain hole of the lubricating cooling).
- Cleaning flywheel housings and blade sliding surfaces on flywheels.
- Check condition of the blade cleaning brushes.
- Greasing of motor flywheel bearings.

8.3 - Monthly maintenance

- Check the tightening of the motor flywheel screws.
- Check that the blade guide bearings on arms are perfect running condition.
- Check the tightening of the screws of the gearmotor, pump and accident protection guarding.

8.4 - Six-monthly maintenance

REDUCTION UNIT

- we suggest to make the first oil replacement after about 300 working hours and wash internal parts carefully. Use synthetic oil SHELL TIVELA OIL 320 type or equivalent.
- The following oil replacement should be made after about 2000 working hours.

VARIATOR UNIT

- Make the oil replacement after about 2000 working hours using the SHELL DONAX TA type or equivalent.

WARNING : absolutely do not mix synthetic oil and mineral oil.

Replace the oil in the hydraulic unit at least once a year using SHELL HYDRAULIC OIL 32 type or equivalent.

- The saw with the ascending arch device, a complete oil change is advisable once a year using SHELL HYDRAULIC OIL 32 or similar.
- Continuity test of the equipotential protection circuit.

8.5 - Oils for lubricating coolant

Considering the vast range of products on the market, the user can choose the one most suited to his own requirements, using as reference the type SHELL LUTEM OIL ECO.

THE MINIMUM PERCENTAGE OF OIL DILUTED IN WATER IS 8 - 10 %.

8.6 - Oil disposal

The disposal of these products is controlled by strict regulations. Please see the Chapter on "**Machine dimensions - Transport - Installation**" in the section on *Dismantling*.

8.7 - Special maintenance

Special maintenance operations must be carried out by skilled personnel.

However, we advise contacting THOMAS or their dealer and/or importer. Also the reset of protective and safety equipment and devices, of the reducer, the motor, the motor pump and electric components is to be considered extraordinary maintenance.



9 MATERIAL CLASSIFICATION AND CHOICE OF TOOL

Since the aim is to obtain excellent cutting quality, the various parameters such as **hardness of the material, shape and thickness, transverse cutting section** of the part to be cut, **selection of the type of cutting blade, cutting speed and control of saw frame lowering**. These specifications must therefore be harmoniously combined in a single operating condition according to practical considerations and common sense, so as to achieve an optimum condition that does not require countless operations to prepare the machine when there are many variations in the job to be performed. The various problems that crop up from time to time will be solved more easily if the operator has a good knowledge of these specifications.

WE THEREFORE RECOMMEND YOU TO ALWAYS USE GENUINE SPARE BLADES THAT GUARANTEE SUPERIOR QUALITY AND PERFORMANCE.

9.1 - Definition of materials

The table at the foot of the page lists the characteristics of the materials to be cut, so as to choose the right tool to use.

9.2 - Selecting blade

First of all the pitch of the teeth must be chosen, in the other words, the number of teeth per inch (25,4 mm) suitable for the material to

be cut, according to these criteria:

- parts with a thin and/or variable section such as profiles, pipes and plate, need close toothing, so that the number of teeth used simultaneously in cutting is from 3 to 6;
- parts with large transverse sections and solid sections need widely spaced toothing to allow for the greater volume of the shavings and better tooth penetration;
- parts made of soft material or plastic (light alloys, mild bronze, teflon, wood, etc.) also require widely spaced toothing;
- pieces cut in bundles require combo tooth design.

9.3 - Teeth pitch

As already stated, this depends on the following factors:

- **hardness of the material**
- **dimensions of the section**
- **thickness of the wall.**

THICKNESS MM	Z CONTINUOUS TOOTH DESIGN	Z COMBO TOOTH DESIGN
TILL 1.5	14	10/14
FROM 1 TO 2	8	8/12
FROM 2 TO 3	6	6/10
FROM 3 TO 5	6	5/8
FROM 4 TO 6	6	4/6
MORE THAN 6	4	4/6

S = THICKNESS

TYPES OF STEEL						CHARACTERISTICS		
USE	I UNI	D DIN	F AF NOR	GB SB	USA AISI-SAE	Hardness BRINELL HB	Hardness ROCKWELL HRB	R=N/mm ²
Construction steels	Fe360	St37	E24	----	----	116	67	360÷480
	Fe430	St44	E28	43	----	148	80	430÷560
	Fe510	St52	E36	50	----	180	88	510÷660
Carbon steels	C20	CK20	XC20	060 A 20	1020	198	93	540÷690
	C40	CK40	XC42H1	060 A 40	1040	198	93	700÷840
	C50	CK50	----	----	1050	202	94	760÷900
	C60	CK60	XC55	060 A 62	1060	202	94	830÷980
Spring steels	50CrV4	50CrV4	50CV4	735 A 50	6150	207	95	1140÷1330
	60SiCr8	60SiCr7	----	----	9262	224	98	1220÷1400
Alloyed steels for hardening and tempering and for nitriding	35CrMo4	34CrMo4	35CD4	708 A 37	4135	220	98	780÷930
	39NiCrMo4	36CrNiMo4	39NCD4	----	9840	228	99	880÷1080
	41CrAlMo7	41CrAlMo7	40CADG12	905 M 39	----	232	100	930÷1130
Alloyed casehardening steels	18NiCrMo7	----	20NCD7	En 325	4320	232	100	760÷1030
	20NiCrMo2	21NiCrMo2	20NCD2	805 H 20	4315	224	98	690÷980
Alloyed for bearings	100Cr6	100Cr6	100C6	534 A 99	52100	207	95	690÷980
Tool steel	52NiCrMoKU	56NiCrMoV7C100K	----	----	----	244	102	800÷1030
	C100KU	C100W1	----	BS 1	S-1	212	96	710÷980
	X210Cr13KU	X210Cr12	Z200C12	BD2-BD3	D6-D3	252	103	820÷1060
	58SiMo8KU	----	Y60SC7	----	S5	244	102	800÷1030
Stainless steels	X12Cr13	4001	----	----	410	202	94	670÷885
	X5CrNi1810	4301	Z5CN18.09	304 C 12	304	202	94	590÷685
	X8CrNi1910	----	----	----	----	202	94	540÷685
	X8CrNiMo1713	4401	Z6CDN17.12	316 S 16	316	202	94	490÷685
Copper alloys Special brass Bronze	Aluminium copper alloy G-CuAl11Fe4Ni4 UNI 5275					220	98	620÷685
	Special manganese/silicon brass G-CuZn36Si1Pb1 UNI5038					140	77	375÷440
	Manganese bronze SAE43 - SAE430					120	69	320÷410
	Phosphor bronze G-CuSn12 UNI 7013/2a					100	56,5	265÷314
Cast iron	Gray pig iron G25					212	96	245
	Spheroidal graphite cast iron GS600					232	100	600
	Malleable cast iron W40-05					222	98	420

SOLID Ø OR L MM	Z CONTINUOUS TOOTH DESIGN	Z COMBO TOOTH DESIGN
TILL 30	8	5/8
FROM 30 TO 60	6	4/6
FROM 40 TO 80	4	4/6
MORE THAN 90	3	3/4

Ø = DIAMETER L = WIDTH

9.4 - Cutting and advance speed

The cutting speed (m/min) and the advance speed (cm²/min = area travelled by the disk teeth when removing shavings) are limited by the development of heat close to the tips of the teeth.

- The cutting speed is subordinate to the resistance of the material ($R = N/mm^2$), to its hardness (HRC) and to the dimensions of the widest section.
- Too high an advance speed (= lowering of the saw frame) tends to cause the disk to deviate from the ideal cutting path, producing non rectilinear cuts on both the vertical and the horizontal plane.

The best combination of these two parameters can be seen directly examining the chips.

Long spiral-shaped chips indicate ideal cutting.



Very fine or pulverized chips indicate lack of feed and/or cutting pressure.



Thick and/or blue chips indicate overload of the blade.



9.5 - Blade running-in

When cutting for the first time, it is good practice to run in the tool making a series of cuts at a low advance speed (= 30-35 cm²/min on material of average dimensions with respect to the cutting capacity and solid section of normal steel with $R = 410-510 N/mm^2$), generously spraying the cutting area with lubricating coolant.

9.6 - Blade structure

Bi-metal blades are the most commonly used. They consist in a silicon-steel blade backing with electron beam or laser welded high speed steel (HSS) cutting edge. The type of stocks are classified in M2, M42, M51 and differ from each other because of their major hardness due to the increasing percentage of Cobalt (Co) and molybdenum (Mo) contained in the metal alloy.

9.7 - Blade type

They differ essentially in their constructive characteristics, such as:

- **shape** and cutting **angle** of tooth
- **pitch**
- **set**

Shape and angle of tooth

REGULAR TOOTH: 0° rake and constant pitch.



Most common form for transversal or inclined cutting of solid small and average cross-sections or pipes, in laminated mild steel and grey iron or general metal.

POSITIVE RAKE TOOTH: 9° - 10° positive rake and constant pitch.

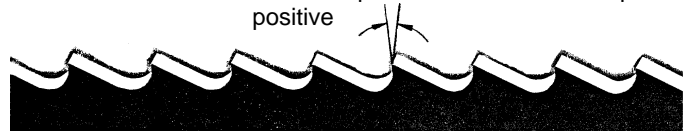

Particular use for crosswise or inclined cuts in solid sections or large pipes, but above all harder materials (highly alloyed and stainless steels, special bronze and forge pig).

COMBO TOOTH: pitch varies between teeth and consequently varying teeth size and varying gullet depths. Pitch varies between teeth which ensures a smoother, quieter cut and longer blade life owing to the lack of vibration.

Another advantage offered in the use of this type of blade in the fact that with an only blade it is possible to cut a wide range of different

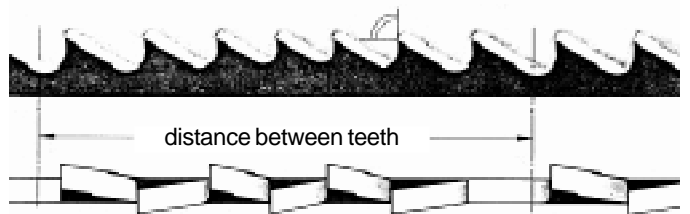

materials in size and type.

COMBO TOOTH: 9° - 10° positive rake.

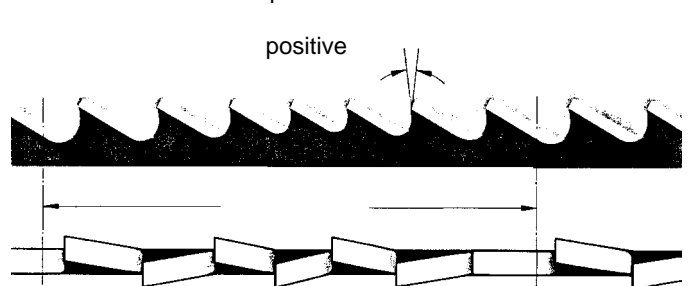

This type of blade is the most suitable for the cutting of section bars and large and thick pipes as well as for the cutting of solid bars at maximum machine capacity. Available pitches: 3-4/4-6.



Set

Saw teeth bent out of the plane of the saw body, resulting in a wide cut in the workpiece.



REGULAR OR RAKER SET: Cutting teeth right and left, alternated by a straight tooth.

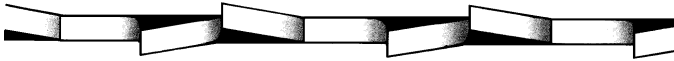

Of general use for materials with dimensions superior to 5 mm. Used for the cutting of steel, castings and hard nonferrous materials.

WAVY SET: Set in smooth waves.



This set is associated with very fine teeth and it is mainly used for

the cutting of pipes and thin section bars (from 1 to 3 mm).

ALTERNATE SET (IN GROUPS): Groups of cutting teeth right and left, alternated by a straight tooth.



This set is associated with very fine teeth and it is used for extremely thin materials (less than 1 mm).

ALTERNATE SET (INDIVIDUAL TEETH): Cutting teeth right and left.



This set is used for the cutting of nonferrous soft materials, plastics and wood.

9.7.1 - RECOMMENDED CUTTING PARAMETERS

STEEL	CUTTING SPEED	LUBRICATION
CONSTRUCTION	60/80	EMULSIFIABLE OIL
CEMENTATION	40/50	EMULSIFIABLE OIL
CARBON STEEL	40/60	EMULSIFIABLE OIL
HARDENING AND TEMPERING	40/50	EMULSIFIABLE OIL
BEARINGS	40/60	EMULSIFIABLE OIL
SPRINGS	40/60	EMULSIFIABLE OIL
FOR TOOLS	30/40	EMULSIFIABLE OIL
FOR VALVES	35/50	EMULSIFIABLE OIL
STAINLESS STEEL	30/40	EMULSIFIABLE OIL
SPHEROIDAL GRAPHITE	20/40	EMULSIFIABLE OIL
CAST IRON	40/60	EMULSIFIABLE OIL
ALUMINIUM	80/600	KEROSENE
BRONZE	70/120	EMULSIFIABLE OIL
HARD BRONZE	30/60	EMULSIFIABLE OIL
BRASS	70/350	EMULSIFIABLE OIL
COPPER	50/720	EMULSIFIABLE OIL



10 MACHINE COMPONENTS

10.1 - List of spare parts

REFERENCE N°	DENOMINATION
1	Bedframe
2	Electric box
3	Electric parts housing guard
4	Revolving arm lock lever
5	Arm lock bush
6	Machine hoisting hook
7	Lateral guard
8	Stroke-end stop
9	Adjustable bracket
10	Refrigerating liquid tank
11	Electropump
12	Bar stop body
13	Bar stop push rod
14	Bar stop rod
15	Revolving arm pin
16	Countervice pin
17	Revolving arm
18	Bearing 32008 X
19	Bushing
20	Screw
21	Hinge pin protection
22	Bearing 32008 X
23	Hinge pin spacer
24	Hinge pin
25	Ring nut guk M 40x1,5
26	Countervice r.h. jaw
27	Countervice l.h. jaw
28	Interchangeable plate
29	Countervice
30	Countervice anterior guard
31	Pieces support
32	
33	Vice support
34	Rack
35	Rack support
36	Vice
37	Vice screw
38	Handwheel
39	Pin
40	Pawl
41	Vice jaw
42	Crucible
43	Ring NILOS 32008 XAV

REFERENCE N°	DENOMINATION
44	Bearing fork
45	Bearing SKF NATV 17 PPI
46	Pin
47	Bearing protection
48	Hydraulic vice cilinder
49	Hinge pin support
50	Sheath
51	Saw frame cylinder support
52	Bush
53	Pin
54	Handle



REFERENCE N°	DENOMINATION
60	Sawframe
61	Electric motor
62	Speed variator
63	Speed variator handwheel
64	Ring nut guk M 40x1,5
65	Speed reducer
66	Spacer
67	
68	Cylinder joint
69	Cylinder superior pin
70	Microswitch
71	Plate
72	Plate
73	Sawframe cylinder
74	
75	Adjustable screw
76	transmission flywheel pin
77	Ring nut guk M 45x1,5
78	Blade tightening slide
79	
80	
81	Handle
82	Blade tightening handwheel pin
83	Pin
84	Blade tightening Cylinder
85	Bracket
86	Ring NILOS 32209 XAV
87	Bearing 32209 XAV
88	
89	Transmission flywheel
90	Ring nut guk M 45 x 1,5
91	Bearing 3309 2RS
92	Ring NILOS 3309 AV
93	Bearing protection
94	Motor flywheel shaft
95	Motor flywheel
96	Cone clamping EUROCONIC
97	Blade guide protection
98	Microswitch
99	R.h Flywheel protection
100	L.h. Flywheel protection
101	Blade guide arm guide
102	L.h. adjustable blade guide arm
103	R.h. adjustable blade guide arm
104	Hand lever
105	
106	Additional protection

REFERENCE N°	DENOMINATION
107	Spacer
108	Bearing 51204
109	Spring washer
110	Manometer
111	Pressure switch
112	Rear crucible
113	
114	Blade guide bearing pin
115	Bearing 6200 2RS
116	Ring seeger Ø 10
117	Upper blade guide pad
118	Lateral blade guide pad
119	Hinge
120	Middle protection
121	Brush
122	Brush support
123	Bearing 626 2RS
124	Brush ring
125	Blade protection
126	Auxiliary blade protection
127	
130	Distributor block
131	Coupling
132	Cooling liquid cock
133	
134	Flexible tube
135	Handgripp

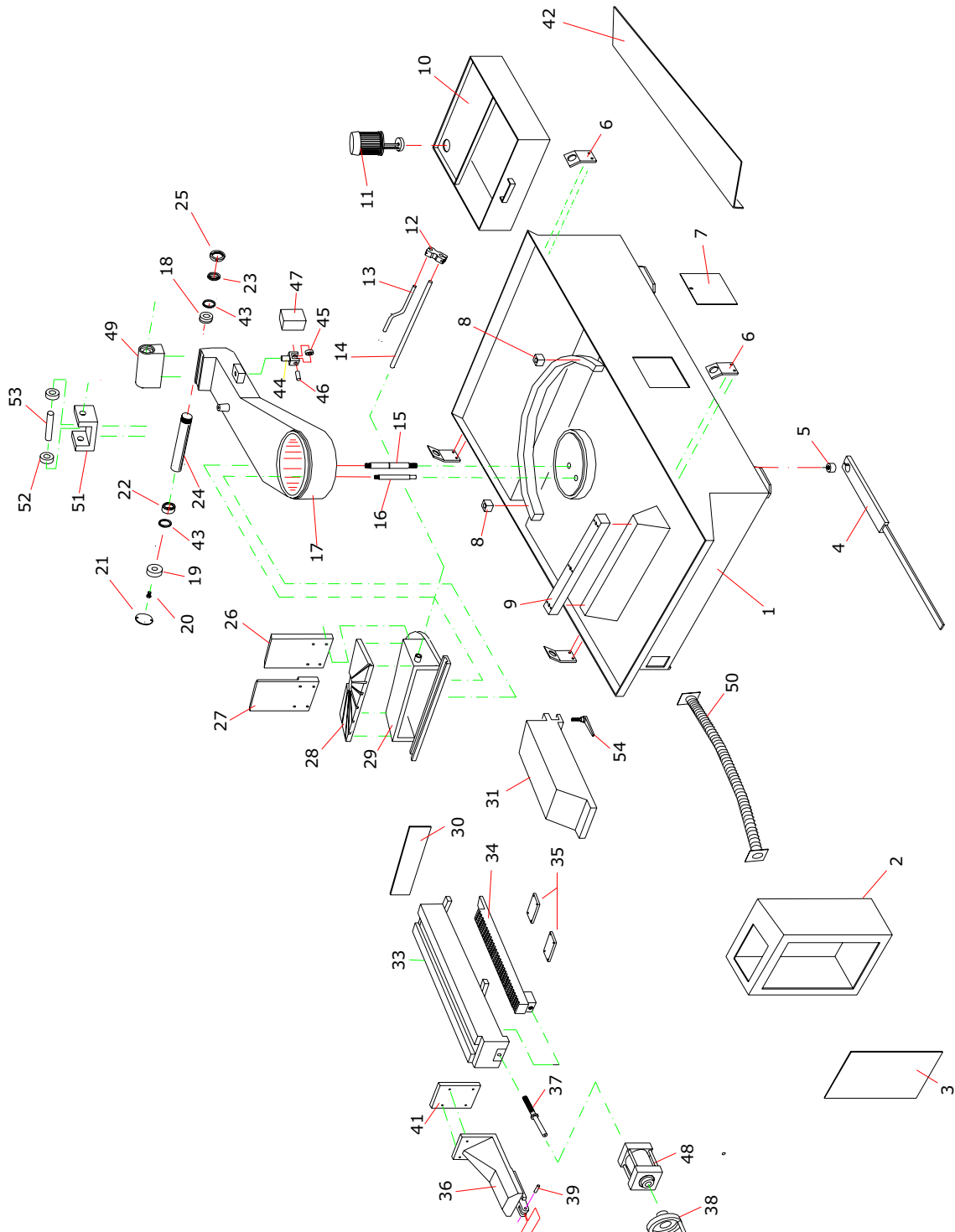

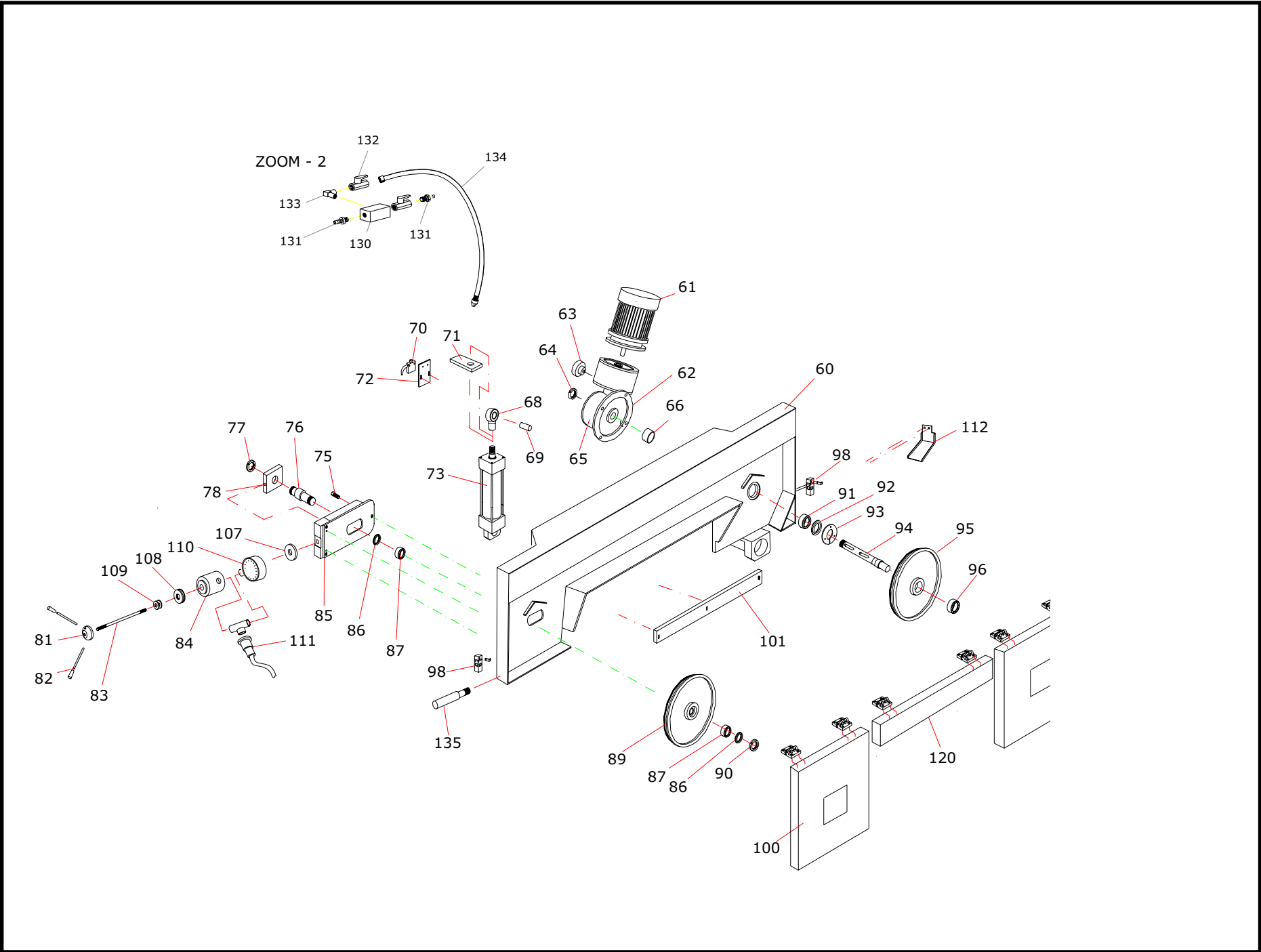

THOMAS

SAR 440SA GDS

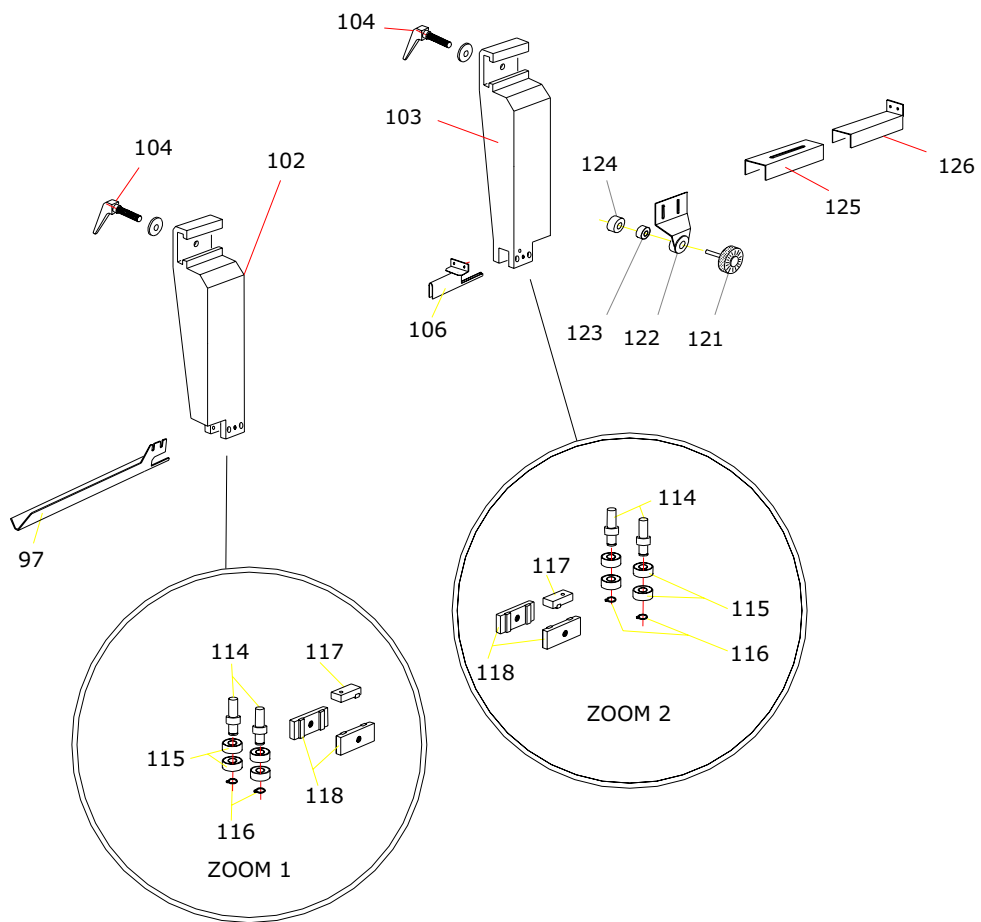

KEY:

- 401 Main switch
- 402 Arch movement selector
- 403 Emergency switch
- 404 STOP button
- 405 Regulator arch descent
- 406 On-line button
- 407 Start button
- 408 Vice selector

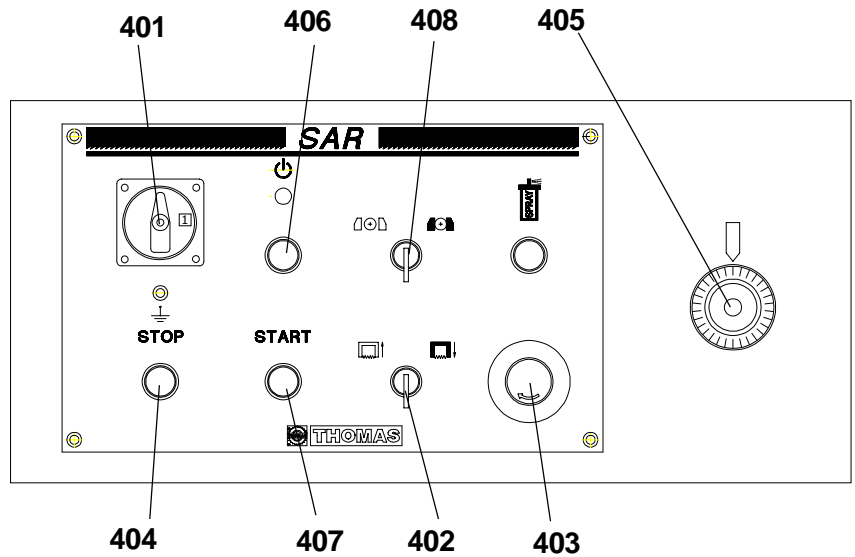

KEY:

- 410 Transformer
- 411 Fuse cartridge
- 412 Relay (Kb)
- 413 Remote switch
- 414 Thermal motor
- 415 Remote switch
- 416 Timer
- 417 Thermal motor

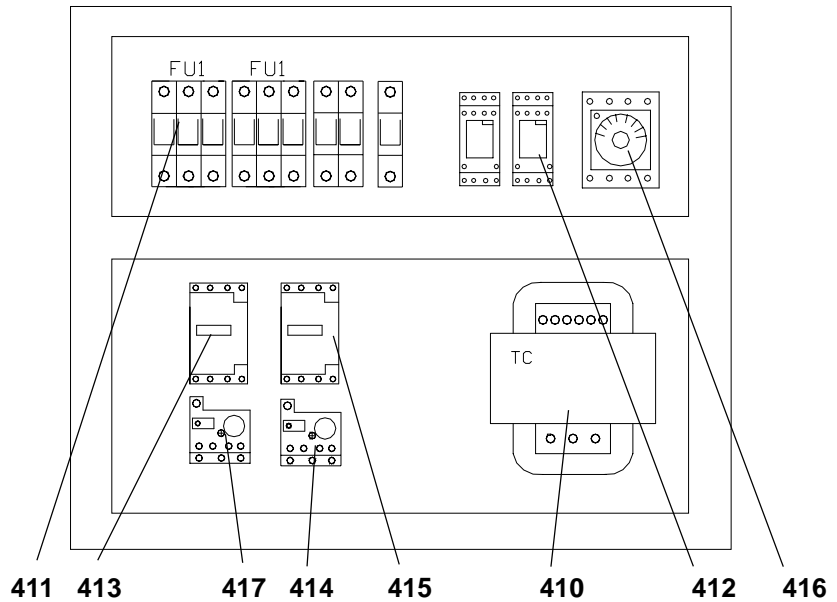

KEY:

- 421 Motor gear case id.
- 422 Vice electrovalve-solenoid
- 423 Gear case tank id.
- 424 Sawframe electrovalve-solenoid

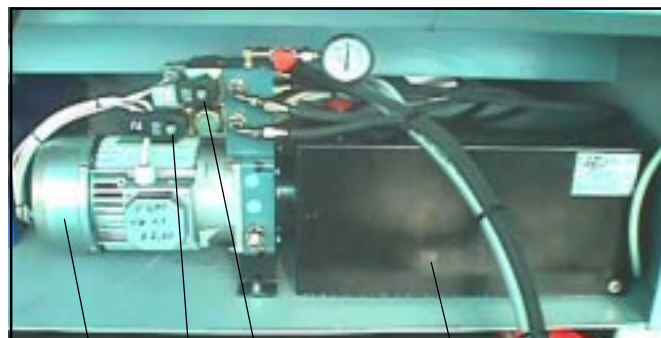

- 421
- 424
- 422
- 423

11 ELECTRIC DIAGRAM

11.1 - Three-phase electric diagram

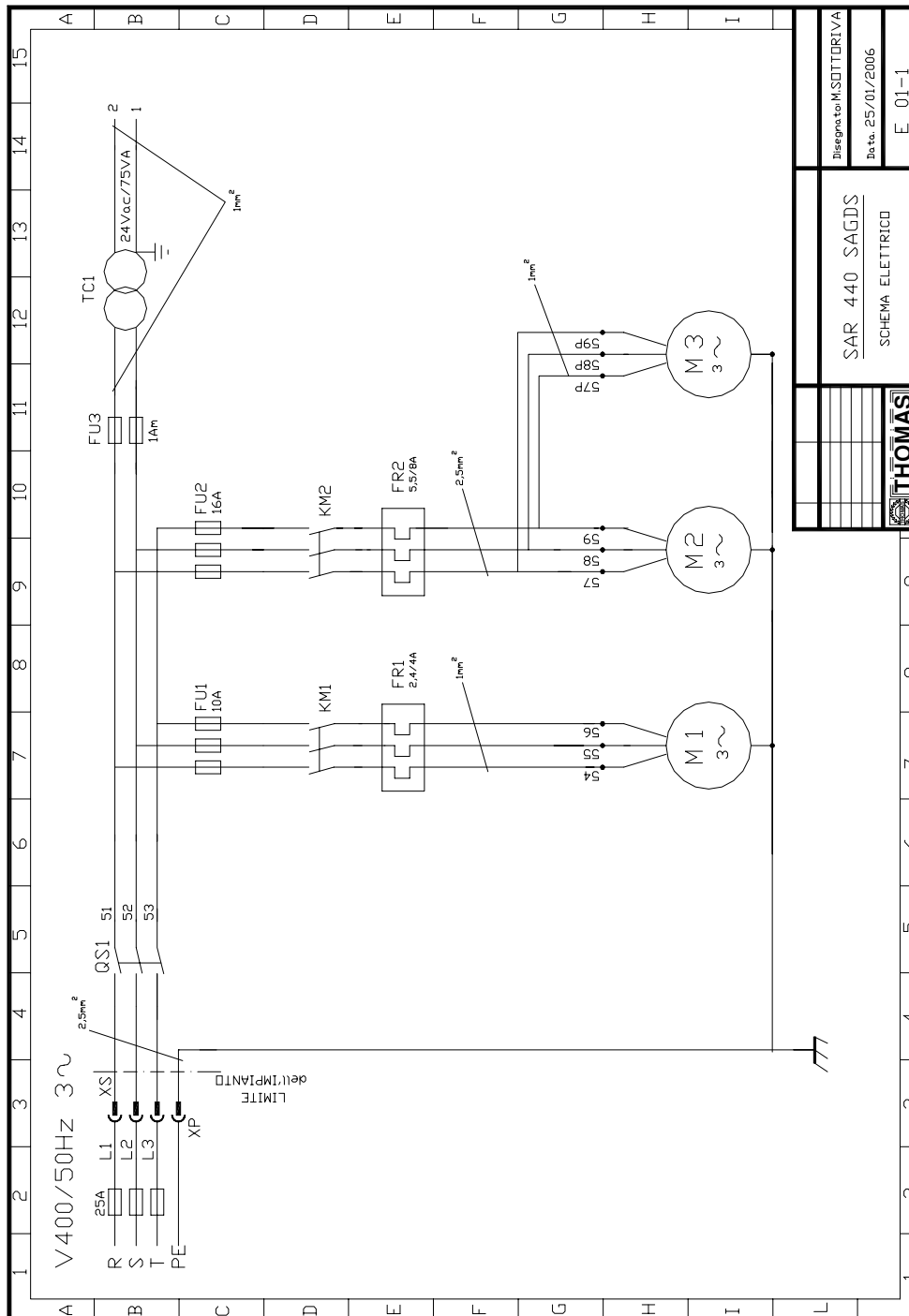

Disegnato: M. SOTTI/DRIVA	
Data: 25/01/2006	
E 01-1	
SAR 440 SAGDS	
SCHEMA ELETTRICO	

- | | | | |
|-----|----------------------------------|-----|---------------------|
| QS1 | Main switch | M1 | Motor gear case id. |
| FU1 | Fuse cartridge | M2 | Belt motor |
| KM1 | Central motor control switch id. | M3 | Motor pump |
| KM2 | Motor belt control switch | FU2 | Fuse cartridge |
| FR2 | Thermal motor belt | TC1 | Transformer |

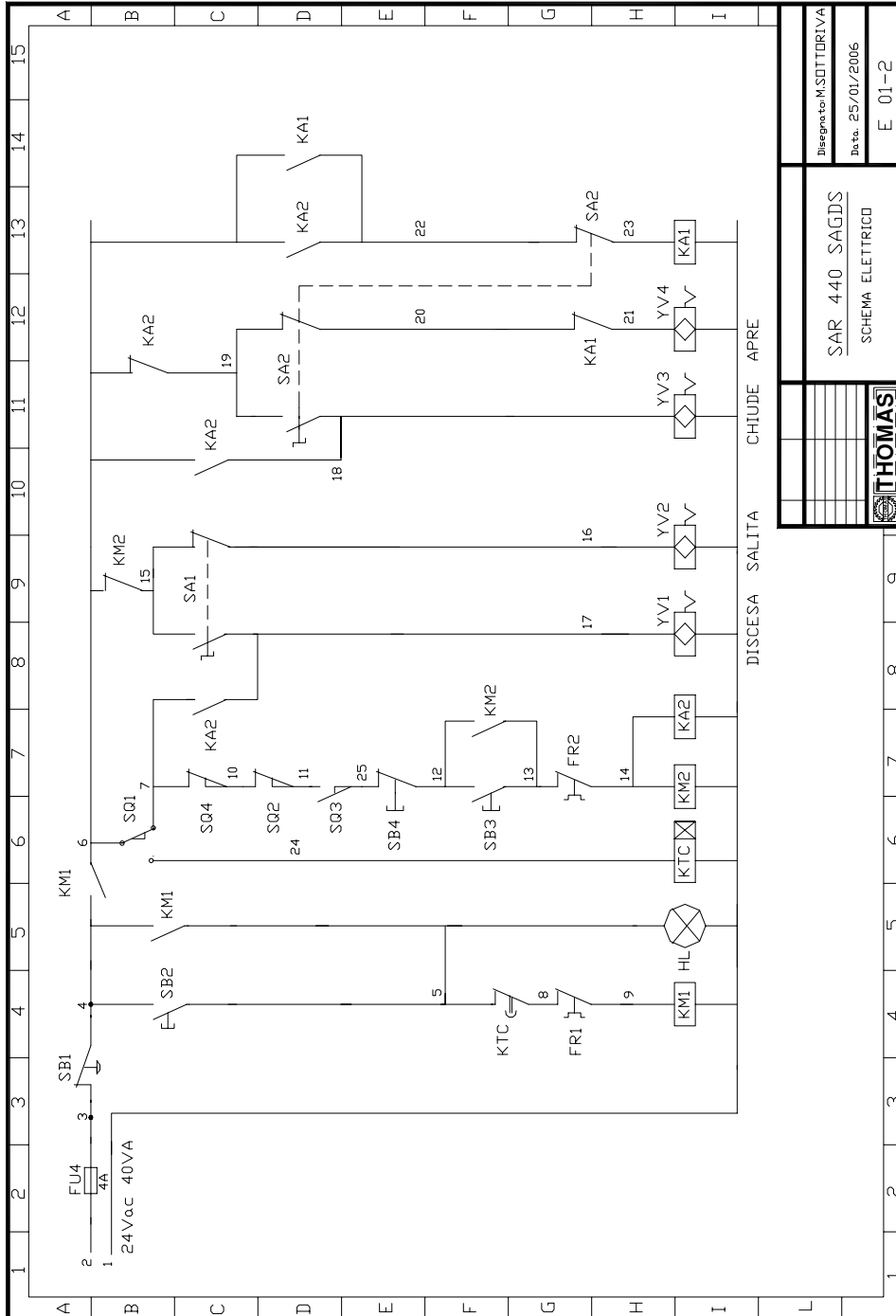

Disegnato: M. SOTTORIVA	
Data: 25/01/2006	
E 01-2	
SAR 440 SA GDS	
SCHEMA ELETTRICO	

11.2 - Hydraulic electric diagram

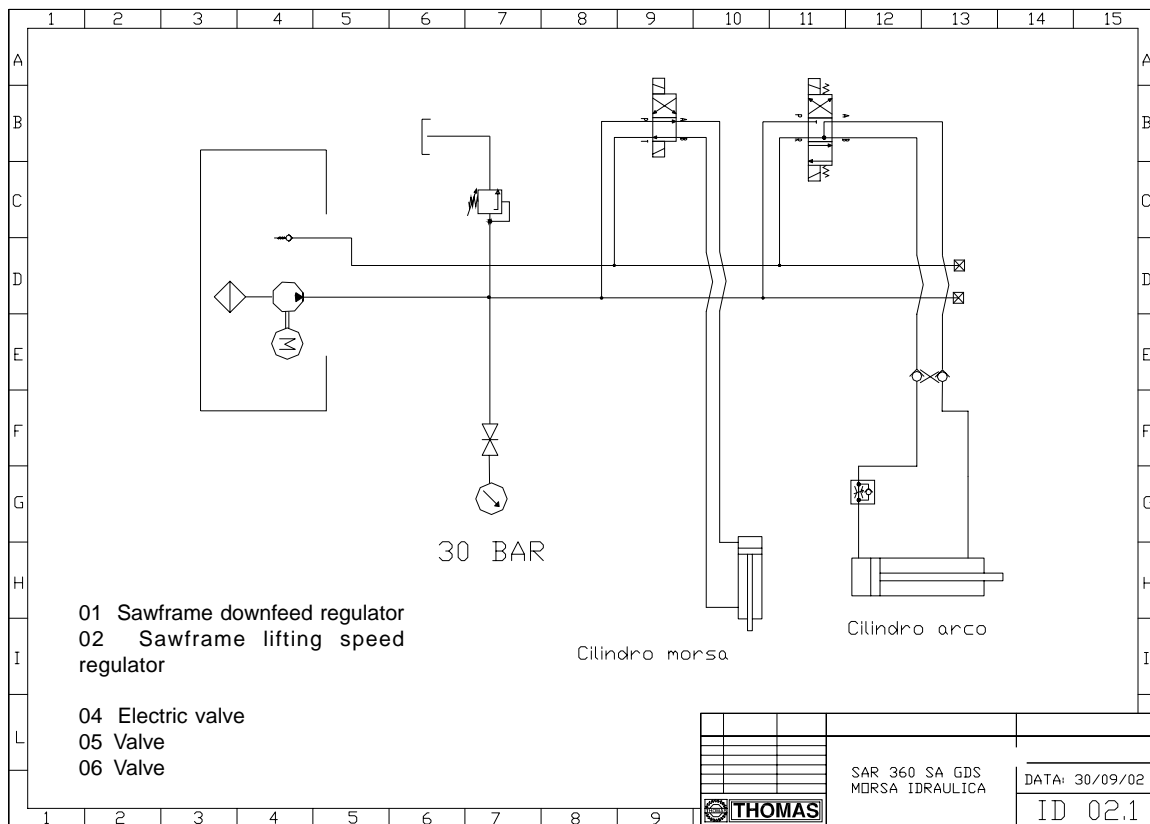

THOMAS		ELENCO COMPONENTI ELETTRICI				DATA:	20/01/06
MOD.: SAR 440 SA GDS		OPTIONAL:	QUANTITA	FORNITORE	ART.	SCH.	1
RIF.	DESCRIZIONE	CARATTERISTICHE					
QS1	INTERUTTORE GENERALE	20 A 600 V, TRIFASE	1	GIOVENZANA	P20 0003 R1		
P-FU1	PORT. X MOTORI CENTRALINA IDRAUL.	32 A 600 V 3 FASI	1	WEBER	PCH 3 X 38		
FU1	FUSIB. PROT MOTORE IDRAULICO	10 A 600 V 10 X 38	3	WEBER	CH10 X 30 10 A		
P-FU2	PORT X PROT MOT. NASTRO E POMPA	32 A 600 V 3 FASI	1	WEBER	PCH 3 X 38		
FU2	FUS. PROT MOT. NASTRO E POMPA	16 A 600 V 10 X 38	3	WEBER	CH 10 X 38 16 A		
P-FU3	PORT. X PROT TRASF.	32 A 600 V 2 FASI	1	WEBER	PCH 2 X 38		
FU3	FUSIBILPROTEZ. TRASFORMATORE	1A 600 V 10 X 38	2	WEBER	CH 10 X 38 1AM		
P-FU4	PORT. X PROT SECOND.	32 A 600 V 1 FASI	1	WEBER	PCH 1 X 38		
FU4	FUS. PROT CIR. AUSILIARIO	4A 600 V 10 X 38	1	WEBER	CH 10 X 38 4A		
TC1	TRASFORMATORE AUS.	75 VA USCITA 24 VOLT	1	F.M.T.	75 VA 24 V. SEC		
KM1	TELERUTTORE CENTR. IDRAULICA	25A 600V 24V	1	C.G.E.	CL00A310 T1		
KM2	TELERUTTORE MOTORE NASTRO	25A 600V 24V	1	C.G.E.	CL00A310 T1		
FR1	TERMICO PROT.MOT. CENTRAL. IDR.	10 A 750 V N.C. 2,5-4 A	1	C.G.E.	RT1 K		
FR2	TERMICO PROT.MOTORE NASTRO	10 A 750 V N.C. 4-6 A	1	C.G.E.	RT1 L		
M1	MOTORE CENTRALINA IDRAULICA	KW 1,1 1400 GIRI	1	TESSARO			
M2	MOTORE NASTRO	KW 2,2 1400 GIRI	1	TESSARO			
M3	POMPA ACQUA	KW 0,11 2800 GIRI H 120	1	SACEMI TRIFASE			
KA1	RELE AUSILIARIO + ZOCCOLO	7A 250 V. 2CONT. SCAMBIO	1	FINDER	55.32 024 +9472		
KA2	RELE AUSILIARIO + ZOCCOLO	5A 250 V. 4CONT. SCAMBIO	1	FINDER	55.34 024 +9474		
HL	SPIA LINEA	24 V. NEON FASTOM V.	1	SIGNALUX	TBF SC1 VE 24V.		
SB1	PULSANTE EMERGENZA	3 A 250 V N.C.	1	TELEMECANIQUE	ZB4 BS 844 + BZ102		
SB2	PULSANTE LINEA	10A 690 V N.O.	1	LOVATO	8LM2 TB108		
SB3	PULSANTE INIZIO CICLO	10A 690 V N.O.	1	LOVATO	8LM2 TB103		
SB4	PULSANTE STOP CICLO	10A 690 V N.C.	1	LOVATO	8LM2 ?		
SA1	SELETTOR MPV. ARCO	10A 690 V + 2 N.O	1	LOVATO	8LM2 TS231		
SA2	SELETTOR MORSA	10A 690 V + 2N.O.+ 2 N.C	1	LOVATO	8LM2 TS220		
YVI---4	VALVOLE IDRAULICHE	SU CENTRALINA	4	L-C-	21,5 V DC RAC 24 V		
SQ2	MICRO RIPARO NASTRO	3 A 250 V CON CHIAVE	1	REITER	RS2 10 11 D		
SQ3	MICRO RIPARO NASTRO	3 A 250 V CON CHIAVE	1	REITER	RS2 10 11 D		
SQ1	MICRO ARCO BASSO	3A 400 V NC+NO	1	PIZZATO	FR 4501		
P	PRESSOSTATO TENS. LAMA	0.5 A 250 V 300 BAR N.O	1	ELETTROTEC	PMN 14K T 90D		
X1	SCATOLA DERIVAZIONE	6 VIE	1	PALAZZOLI	TAIS 101061		
X2	MORSETTI CONNESSIONE	2,5 MM 800 V	47	SIEMENS	8W A 11 011 DF11		
X3	MORSETTI CONNESSIONE	TERMINALI	2	WEIDMULLER	EW 35		
KTC	TEMPORIZZATORE + ZOCCOLO	2 C. SCAMBIO 300 SEC	1	CROUZET	TOP 36 24 V+ 9026		
KM1-C	CONTATTO AUS. CENTRALINA	1 NC+ 1 NO 10A 750 V.	1	C.G.E.	BCLF 10+BCLF01		
KM2-C	CONTATTO AUS. NASTRO	1 NC + NO 10 A 750 V.	1	C.G.E.	BCLF 10+BCLF01		

12 TROUBLESHOOTING

This chapter lists the probable faults and malfunctions that could occur while the machine is being used and suggests possible remedies for solving them.

The first paragraph provides diagnosis for TOOLS and CUTS, the second for ELECTRICAL COMPONENTS.

12.1 - Blade and cut diagnosis

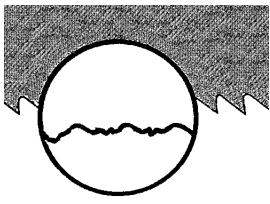
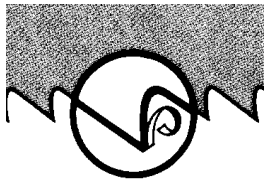
FAULT	PROBABLE CAUSE	REMEDY
<p>TOOTH BREAKAGE</p>  	<p>Too fast advance</p> <p>Wrong cutting speed</p> <p>Wrong tooth pitch</p> <p>Chips sticking onto teeth and in the gullets or material that gums</p> <p>Defects on the material or material too hard</p> <p>Ineffective gripping of the part in the vice</p> <p>The blade gets stuck in the material</p> <p>Starting cut on sharp or irregular section bars</p> <p>Poor quality blade</p> <p>Previously broken tooth left in the cut</p> <p>Cutting resumed on a groove made previously</p> <p>Vibrations</p> <p>Wrong tooth pitch or shape</p> <p>Insufficient lubricating refrigerant or wrong emulsion</p> <p>Teeth positioned in the direction opposite the cutting direction</p>	<p>Decrease advance, exerting less cutting pressure. Adjust the braking device if mounted on the machine.</p> <p>Change speed and/or type of blade. See chapter on “Material classification and blade selection”, in the section <i>Blade selection table according to cutting and feed speed</i>.</p> <p>Choose a suitable blade. See Chapter “Material classification and blade selection”.</p> <p>Check for clogging of cooling liquid drain holes on the blade-guide pads and that flow is plentiful in order to facilitate the removal of chips from the blade.</p> <p>Material surfaces can be oxidised or covered with impurities making them, at the beginning of the cut, harder than the blade itself, or have hardened areas or inclusions inside the section due to productive agents used such as casting sand, welding wastes, etc. Avoid cutting these materials or in any case perform cutting with extreme care, cleaning and removing such impurities as quickly as possible.</p> <p>Check the gripping of the part.</p> <p>Reduce feed and exert less cutting pressure. Pay more attention when you start cutting.</p> <p>Use a superior quality blade.</p> <p>Accurately remove all the parts left in.</p> <p>Make the cut elsewhere, turning the part.</p> <p>Check gripping of the part.</p> <p>Replace blade with a more suitable one. See “Material classification and blade selection” in the <i>Blade Types</i> section. Adjust blade guide pads.</p> <p>Check level of liquid in the tank. Increase the flow of lubricating refrigerant, checking that the hole and the liquid outlet pipe are not blocked.</p> <p>Check the emulsion percentage.</p> <p>Turn teeth in correct direction.</p>

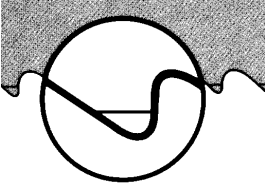
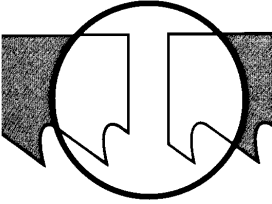
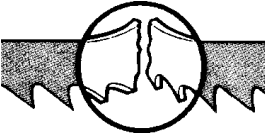
FAULT	PROBABLE CAUSE	REMEDY
<p>PREMATURE BLADE WEAR</p> 	<p>Faulty running-in of blade</p> <p>Teeth positioned in the direction opposite the cutting direction</p> <p>Poor quality blade</p> <p>Too fast advance</p> <p>Wrong cutting speed</p> <p>Defects on the material or material too hard</p> <p>Insufficient lubricating refrigerant or wrong emulsion</p>	<p>See “Material classification and blade selection” in the <i>Blade running-in</i> section.</p> <p>Turn teeth in correct direction.</p> <p>Use a superior quality blade.</p> <p>Decrease advance, exerting less cutting pressure. Adjust the braking device if mounted on the machine.</p> <p>Change speed and/or type of blade. See chapter on “Material classification and blade selection”, in the section <i>Blade selection table according to cutting and feed speed</i>.</p> <p>Material surfaces can be oxidised or covered with impurities making them, at the beginning of the cut, harder than the blade itself, or have hardened areas or inclusions inside the section due to productive agents used such as casting sand, welding wastes, etc. Avoid cutting these materials or in any case perform cutting with extreme care, cleaning and removing such impurities as quickly as possible.</p> <p>Check level of liquid in the tank. Increase the flow of lubricating refrigerant, checking that the hole and the liquid outlet pipe are not blocked.</p> <p>Check the emulsion percentage.</p>
<p>BLADE BREAKAGE</p>  	<p>Faulty welding of blade</p> <p>Too fast advance</p> <p>Wrong cutting speed</p> <p>Wrong tooth pitch</p> <p>Ineffective gripping of the part in the vice</p> <p>Blade touching material at beginning of cut</p>	<p>The welding of the blade is of utmost importance. The meeting surfaces must perfectly match and once they are welded they must have no inclusions or bubbles; the welded part must be perfectly smooth and even. They must be evenly thick and have no bulges that can cause dents or instant breakage when sliding between the blade guide pads.</p> <p>Decrease advance, exerting less cutting pressure. Adjust the braking device if mounted on the machine.</p> <p>Change speed and/or type of blade. See chapter on “Material classification and blade selection”, in the section <i>Blade selection table according to cutting and feed speed</i>.</p> <p>Choose a suitable blade. See Chapter “Material classification and blade selection”.</p> <p>Check the gripping of the part.</p> <p>At the beginning of the cutting process, never lower the saw frame before starting the blade motor.</p>

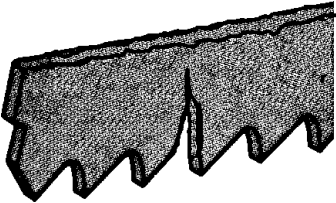
FAULT	PROBABLE CAUSE	REMEDY
	<p>Blade guide pads not regulated or dirty because of lack of maintenance</p> <p>Blade guide block too far from material to be cut</p> <p>Improper position of blade on flywheels</p> <p>Insufficient lubricating refrigerant or wrong emulsion</p>	<p>Check distance between blocks (see “Machine adjustments” in the <i>Blade Guide Blocks</i> section): extremely accurate guiding may cause cracks and breakage of the tooth. Clean carefully.</p> <p>Approach head as near as possible to material to be cut so that only the blade section employed in the cut is free, this will prevent deflections that would excessively stress the blade.</p> <p>The back of blade rubs against the support due to deformed or poorly welded bands (tapered), causing cracks and swelling of the back contour.</p> <p>Check level of liquid in the tank. Increase the flow of lubricating refrigerant, checking that the hole and the liquid outlet pipe are not blocked. Check the emulsion percentage.</p>
<p>STREAKED OR ETCHED BANDS</p>	<p>Damaged or chipped blade guide pad</p> <p>Tight or slackened blade guide bearing</p>	<p>Replace it.</p> <p>Adjust it (see Chapter “Machine adjustments” in <i>Blade guide</i> section).</p>
<p>CUTS OFF THE STRAIGHT</p>	<p>Blade not parallel as to the counter-vice</p> <p>Blade not perpendicular due to the excessive play between the guide pads and maladjustment of the blocks</p> <p>Too fast advance</p> <p>Blade guide block too far from material to be cut</p> <p>Worn out blade</p> <p>Wrong tooth pitch</p>	<p>Check fastenings of the blade guide blocks as to the counter-vice so that they are not too loose and adjust blocks vertically; bring into line the position of the degrees and if necessary adjust the stop screws of the degree cuts.</p> <p>Check and vertically re-adjust the blade guide blocks; reset proper side guide play (see Chapter “Machine adjustments” in <i>Blade guide</i> section).</p> <p>Decrease advance, exerting less cutting pressure. Adjust the braking device if mounted on the machine.</p> <p>Approach it as near as possible to material to be cut so that only the blade section employed in the cut is free, this will prevent deflections that would excessively stress the blade.</p> <p>Replace it.</p> <p>Blade with major density of teeth is being used, try using one with less teeth (see Chapter “Material classification and blade selection” in the <i>Blade Types</i> section).</p>

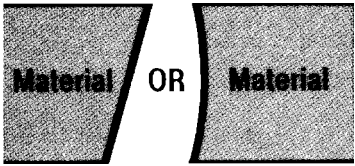
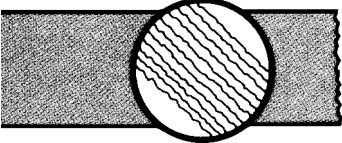
FAULT	PROBABLE CAUSE	REMEDY
	<p>Broken teeth</p> <p>Insufficient lubricating refrigerant or wrong emulsion</p>	<p>Irregular work of the blade due to the lack of teeth can cause deflection in the cut; check blade and if necessary replace it.</p> <p>Check level of liquid in the tank. Increase the flow of lubricating refrigerant, checking that the hole and the liquid outlet pipe are not blocked.</p> <p>Check the emulsion percentage.</p>
<p>FAULTY CUT</p> 	<p>Worn out flywheels</p> <p>Flywheel housing full of chips</p>	<p>The support and guide flange of the band are so worn out that they cannot ensure the alignment of the blade, causing faulty cutting; blade rolling and drawing tracks can have become tapered. Replace them.</p> <p>Clean with compressed air.</p>
<p>STREAKED CUTTING SURFACE</p> 	<p>Too fast advance</p> <p>Poor quality blade</p> <p>Worn out blade or with chipped and/or broken teeth</p> <p>Wrong tooth pitch</p> <p>Blade guide block too far from material to be cut</p> <p>Insufficient lubricating refrigerant or wrong emulsion</p>	<p>Decrease advance, exerting less cutting pressure. Adjust the braking device if mounted on the machine.</p> <p>Use a superior quality blade.</p> <p>Replace it.</p> <p>Blade used probably has too large teeth; use one with more teeth (see "Material classification and blade selection" in the <i>Blade Types</i> section).</p> <p>Approach it as near as possible to material to be cut so that only the blade section employed in the cut is free, this will prevent deflections that would excessively stress the blade.</p> <p>Check level of liquid in the tank. Increase the flow of lubricating refrigerant, checking that the hole and the liquid outlet pipe are not blocked.</p> <p>Check the emulsion percentage.</p>
<p>NOISE ON GUIDE BLOCKS</p>	<p>Chipped bearings</p> <p>Worn out or damaged pads</p>	<p>Dirt and/or chips between blade and guide bearings. Replace them.</p> <p>Replace them.</p>



12.2 - Electrical components diagnosis

FAULT	PROBABLE CAUSE	REMEDY
MACHINE DOES NOT WORK	Power supply Main disconnect switch Fuses " FU 1 " " SQ 1 " safety microswitch Blade tightening microswitch Emergency button " SB 1 " on Cycle reset or line button " SB 2 " Thermal relay of main motor Transformer " TC 1 " Fuse " FU 2 - FU 3 " Microswitch " SQ 2 "	Check: - phases - cables - socket - plug Voltage must arrive upstream from the fuses (terminal board). It must be turned to ON position. Check electrical efficiency. Check power line connections and relative terminals. Check electrical efficiency and check for shorts that trigger these protections on the power side of the circuit. Check closing of the flywheel guard. Check the efficiency of the device; replace it if damaged. Make sure to have tightened the blade with the relevant handwheel and to have actuated the microswitch. Ensure that it is off and that its contacts are unbroken. Check mechanical efficiency; replace if damaged. Check that thermal relay protecting main motor is correctly connected. Check that the supply voltage is the same as the line voltage and that it gives a value of 24 V at output. Check fuse efficiency and ensure there are no short circuits causing the protection on the control side of the circuit. After having raised the saw frame, check that the microswitch is not engaged and if necessary check operating efficiency.
MOTOR STOPPED WITH PILOT LIGHT "HL" LIT	Remote-control switch " KM " Motor " M 1 "	Check that phases are present at both input and output; ensure that it is not blocked, that it closes when fed, that it does not cause short circuits; otherwise change it. Check that it is not burnt and that it turns freely. It may be rewound or changed.

13 NOISE TESTS

In accordance with point 1.7.4.f of the Machines Directive EEC 98/37

2 measurements with the machine operating unloaded.

- The microphone was been located close to the operator's head, at medium height.
- The weighted equivalent continuous acoustic pressure level was 65,4 dB (A).
- The maximum level of the WEIGHTED instantaneous acoustic pressure C was always less than 130 dB.

NOTE: with the machine operating, the noise level will vary according to the different materials being processed. The user must therefore assess the intensity and if necessary provide the operators with the necessary personal protection, as required by Law 277/1991.

PLATES AND LABELS

